

Handheld Oscilloscopes

THS3000 Series Data Sheet



Features & Benefits

Key Performance Specifications

- 100 MHz or 200 MHz Bandwidth Models
- Maximum Sample Rates up to 5 GS/s and 200 ps Resolution
- 4 Fully Isolated and Floating Channels
- 600 V_{RMS} CAT III, 1000 V_{RMS} CAT II Rated Inputs (BNC to Earth Ground)

Measurement and Analysis

- 21 Automatic Measurements
- Waveform Math and FFT Spectral Analysis
- Volts, Time, Frequency, Watts Cursor Measurements

Application Functions

- Measurement Data Logging with TrendPlot™
- Waveform Pass/Fail Limit Testing
- Automatic 100 Display Screens Recorder

Ease of Use Features

- 6 in. (153 mm) Bright Color Display
- USB Device and Host Support
- 7 Hours of Continuous Battery Operation

Applications

- Embedded Analog and Digital Design
- Power Devices, Power Electronics, and Power Supply Design
- Automotive and Avionics Design and Maintenance
- Industrial Equipment Design and Installation
- Field Test and Service

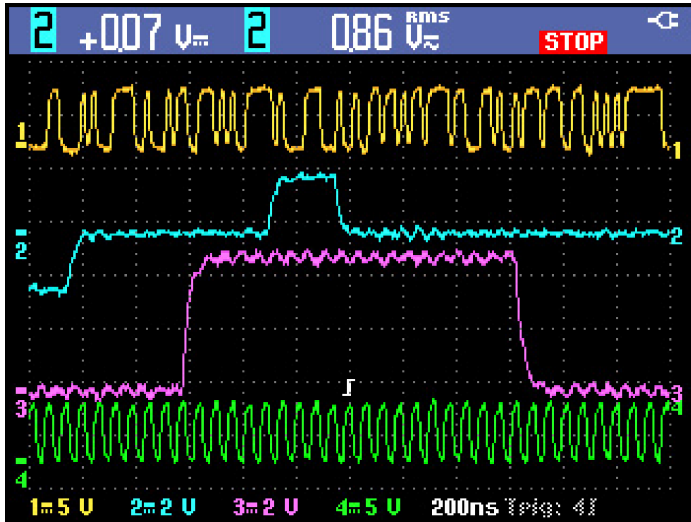

Four isolated input channels easily handle any type of mixed signal inputs.

Portable Performance for Challenging Environments

With 4 isolated channels and up to 7 hours of battery life, the lightweight THS3000 Handheld Oscilloscope Series enables you to safely make floating or differential measurements on your bench or in the field. Now you can tackle tough environments with the performance you expect from Tektronix – safely and affordably.

Accurately Measure Your Signals

With up to 200 MHz bandwidth, 4 channels, and 5 GS/s maximum sample rate, no other oscilloscope offers as much bandwidth and sample rate in a portable handheld form factor. The THS3000 Handheld Oscilloscope Series has 10,000 points record length per channel, enabling you to capture more signal information at higher sample rates to clearly see signal details. For applications where it is important to measure slow-changing signals over long time periods, the THS3000 Series offers Roll mode that extends the record length to 30,000 points of signal information.

Safely Make Floating and Differential Measurements

Making accurate and safe measurements on power electronics, power semiconductors, and other electronics applications can be challenging when the signal reference is floating and not referenced to earth ground. When your signal ranges from low voltage to high voltage (kV) or you must use probing techniques that can potentially create ground loops, the problem is compounded.

To enable floating measurements, the THS3000 Series is architecturally different than most other oscilloscopes. All input channels are fully isolated

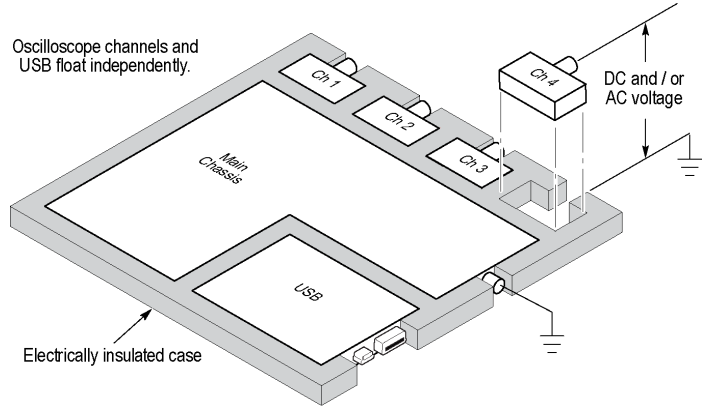

Isolated-channel technology is specified to 1000 V_{RMS} maximum float voltage.

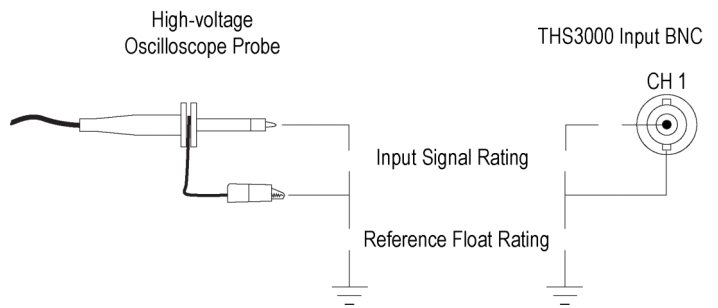

Input signal and float voltage maximum safety ratings.

from the main chassis and from each other. Additionally the power adapter and USB interface are fully isolated to ensure safe measurements and eliminate the risk of unintentional grounding or accidental short circuits. When configured with the proper probes you can be assured you'll be able to make quick, safe, and accurate measurements.

Selecting the Right Probe

| Scope/Probe (Attenuation) | Maximum Safety Rating | | THS3000 Viewable Signal | |
|---------------------------|--|------------------------------|-------------------------|-----------------------|
| | Reference Float Safety Rating* ¹ | Input Signal Safety Rating | On-screen P-P Voltage | On-screen RMS Voltage |
| THS3000 (1X input) | 600 V _{RMS} CAT III 1000 V _{RMS} CAT II | 300 V _{RMS} CAT III | 800 V _{P-P} | 282 V _{RMS} |
| THP0301 (10X) | 300 V _{RMS} CAT III | 300 V _{RMS} CAT III | 849 V _{P-P} | 300 V _{RMS} |
| P5150 (50X) | 600 V _{RMS} CAT II | 1000 V _{RMS} CAT II | 2828 V _{P-P} | 1000 V _{RMS} |
| P5122 (100X) | 600 V _{RMS} CAT II | 1000 V _{RMS} CAT II | 2828 V _{P-P} | 1000 V _{RMS} |

*¹ Passive probe reference leads have no attenuation so any working voltage or overvoltage transients pass straight through to the scope reference. Thus, a passive probe reference float rating can never exceed the scope reference float rating.

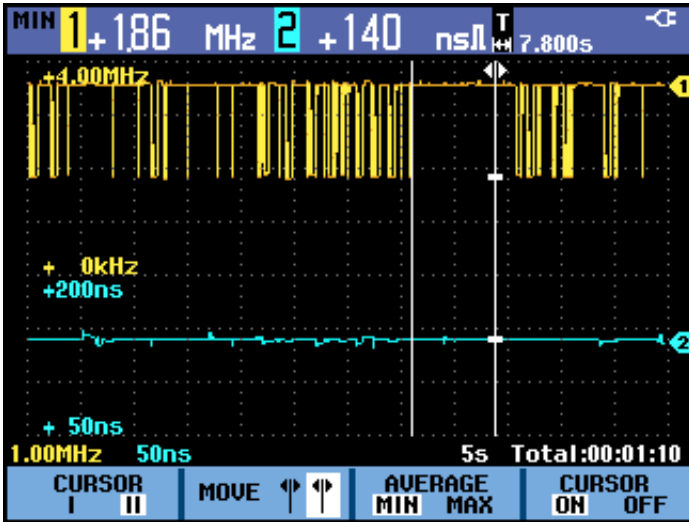

Analyze measurements and recordings visually or using measurement cursors.

Fast Analysis of Your Device

The THS3000 Handheld Oscilloscope Series is packed with analysis tools to help you validate your device's operation and identify issues quickly. With waveform math, you can add, subtract, or multiply any of your signals to investigate instantaneous power or look at gain. Vertical and horizontal cursors allow you to look at a specific point on your waveform for accurate measurements of voltage, current, time, or frequency. With 21 automated measurements, you can make common measurements quickly and accurately. The built-in Fast Fourier Transform (FFT) function allows you to see the frequency spectrum of your signal, revealing signal interference, crosstalk, or switching noise.

Find Intermittent Faults with TrendPlot™

Intermittent faults can be caused by timing errors, temperature changes, environmental influences, or simply broken wiring or connectors. The TrendPlot™ function helps you find those faults by plotting minimum and maximum measurement values over time. You can select up to 4 measurements and plot any combination of voltages, amps, frequency, time, and phase for any or all four inputs, all with time capture information.

Automatic Capture and Data Logging of 100 Display Screens

Capturing random or changing signals can often be difficult. The THS3000 Series greatly simplifies any type of waveform data logging by continuously capturing 100 display screens. Each screen capture can include multiple channels and math waveforms, each with its own time stamp. Data capture can also be tailored to specific events by selection of

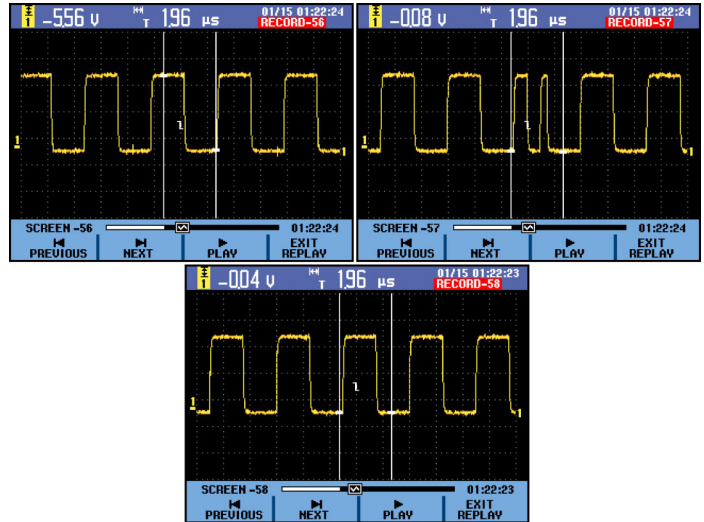

Playback of captured data is quick and easy with the THS3000 Series oscilloscopes.

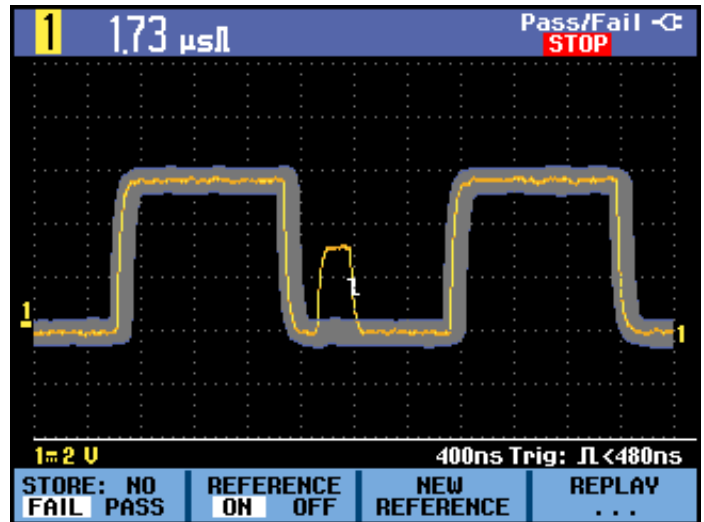

User-defined limit testing can easily identify random waveform anomalies.

qualified trigger conditions. Playback is quick and easy with the automatic replay of all captured screens or only the screens you select.

Waveform Limit Testing

The THS3000 Series can automatically monitor your signals and output Pass or Fail results by judging whether the input waveform is within predefined boundaries. User selections can include testing one or all input channels and automatic recording of Pass or Fail data. Data can easily be reviewed using the Replay mode or stored externally to a USB memory device.

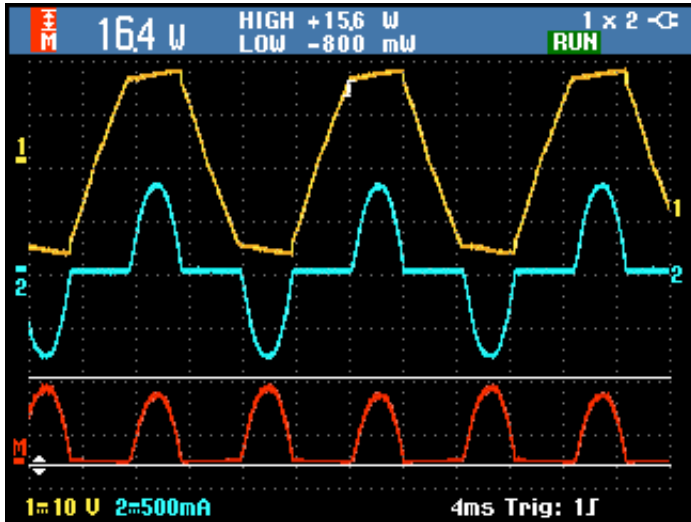

Easily calculate the instantaneous power by multiplying voltage and current waveforms.

Complete Solution for Power Measurements

For performing power measurement on motor drives, power converters/inverters, and power semiconductor devices the THS3000 Series is equipped to handle most common measurements. For basic debugging, the isolated input channels can be used with a variety of voltage and current probes. Each input channel can be configured to match the probe type and attenuation ensuring correct measurements and cursor readings. Four channels allow for easy measurements of three-phase power or simultaneous capture of digital control and power signals.

Measurements on power conversion electronics usually require probes with higher voltage ratings. Tektronix offers a passive probe with insulation systems specifically designed for making floating measurements. The standard THP0301-X can measure up to 849 V_{p-p} (300 V_{RMS}). Optional P5122 probes, when coupled with the THS3000 Series, are suitable for making measurements on 1000 V_{RMS} devices in Category II environments, with a maximum float voltage of up to 600 V_{RMS} relative to earth ground.

Designed to Make Your Work Easier

Intuitive Operation

The THS3000 Handheld Oscilloscope Series has a front-panel layout and an intuitive user interface which makes the instrument easy to use, reducing learning time and increasing efficiency. For initial setup or for situations where you're constantly changing connection points, the THS3000 Series has a single-button Autoset and Autorange feature which can automatically set up the trigger system and adjust vertical and/or horizontal oscilloscope settings.

Easy to Use

The bright color display makes it easy for you to see the signals you're measuring. Each waveform is color coded and designed to correspond to the colors on the input probe connectors, the front-panel channel selector

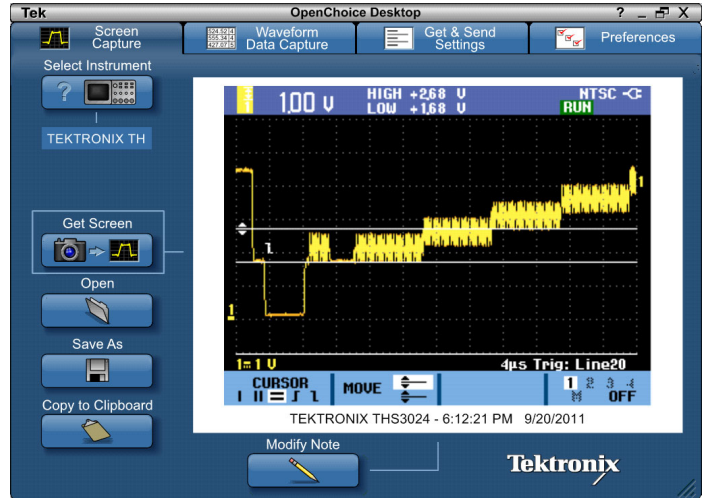

Tektronix OpenChoice® desktop software extends the capabilities of your instrument.



The standard USB ports facilitate data storage, data transfer, and instrument control.

buttons, and the individual probes which are colored at both ends. By matching the colors during setup you'll be assured you can easily identify your waveforms.

For setup assistance user messages are available in 11 user-selectable languages including English, French, German, Spanish, Portuguese, Italian, Japanese, Simplified and Traditional Chinese, Korean, and Russian.

Flexible Data Transfer

The THS3000 Series oscilloscopes come with both a USB host and USB mini port located on the side panel enabling you to quickly and easily save instrument settings, screenshots, and waveform data onto a flash device or transfer the data directly to a PC. The THS3000 Series is shipped with the Tektronix OpenChoice® desktop software, allowing you to integrate your new THS3000 Series oscilloscope into existing measurement systems and take advantage of extended functionalities in data acquisition, measurement analysis, and documentation.

Versatility and Portability for Wherever Your Job Takes You

With a battery life of 7 hours and a weight of only 4.8 lb. (2.2 kg) the THS3000 Handheld Oscilloscope Series offers ultimate portability. Measurements taken in the lab can now be conveniently correlated with those taken in the field – all on the same instrument. Rated IP41, the THS3000 Series features the ruggedness needed to go beyond the lab and into industrial and field environments. The optional travel kit comes with a hard-sided carrying case and useful accessories allowing you to take the THS3000 Series on the road securely and conveniently. From the lab to the field, the THS3000 Handheld Oscilloscope Series offers you the versatility of using a single, high-performance instrument suitable for a wide range of working environments.

Performance You Can Count On

In addition to industry-leading service and support, every THS3000 Series oscilloscope comes backed with a three-year standard warranty, and ships with a Certificate of Traceable Calibration Standard.

Characteristics

Vertical System Analog Channels

| Characteristic | THS3014 | THS3024 |
|---|--|---------|
| Isolated Input Channels | 4 | 4 |
| Analog Bandwidth (–3 dB) | 100 MHz | 200 MHz |
| Rise Time | 3.5 ns | 1.7 ns |
| Hardware Bandwidth Limits | 20 kHz, 20 MHz, or full | |
| Input Coupling | AC, DC | |
| Input Impedance | 1 M Ω \pm 1%, 14 pF \pm 2 pF | |
| Input Sensitivity Range | 2 mV/div to 100 V/div | |
| Vertical Resolution | 8 bits | |
| DC Gain Accuracy | \pm 2.1% of reading +0.04 \times range/div for 5 mV/div to 100 V/div | |
| Max BNC Input Voltage | (1 M Ω) 300 V _{RMS} CAT III from BNC signal to BNC shell | |
| Max Probe Voltage (with standard THP0301-X probe) | 300 V _{RMS} CAT III from 10:1 probe tip signal to BNC and reference lead | |
| Float Voltage | 1000 V _{RMS} CAT II / 600 V _{RMS} CAT III from BNC shell to earth ground | |
| Trace Positioning | \pm 4 divisions | |

Horizontal System

| Characteristic | THS3014 | THS3024 |
|--------------------------------------|--|-------------------------|
| Maximum Sample Rate | 2.5 GS/s (1.25 GS/s 4-ch) | 5 GS/s (1.25 GS/s 4-ch) |
| Maximum Record Length (All channels) | 10,000 points (30,000 points in Roll mode (4 ms to 2 min / div)) | |
| Time-base Range (s/div) | 5 ns to 4 s | 2 ns to 4 s |
| Delay Time Range | 1 full screen (12 divisions) of pre-trigger or up to 100 screens (1,200 divisions) of post-trigger | |
| Timing Accuracy | \pm 100 ppm + 0.04 div | |
| Zoom | Horizontally expand or compress a live or stopped waveform | |



The optional travel kit (TK) version includes a hard-sided carry case for your instrument, accessories, and storage space for a laptop PC.

Trigger System

| Characteristic | Description |
|--------------------|---|
| Input Source | Channel 1, 2, 3, or 4. All input references isolated from each other and earth ground |
| Main Trigger Modes | Auto-level, Auto, Normal, and Single |
| Trigger Coupling | DC, HF Reject, Noise Reject (reduces sensitivity) |

Trigger Sensitivity

| Characteristic | Description |
|---------------------|---|
| Internal DC Coupled | 0.5 divisions from DC to 5 MHz at >5 mV/div 1 divisions >5 MHz to 200 MHz (THS3024) 1 divisions >5 MHz to 100 MHz (THS3014) |

Trigger Level Range

| Characteristic | Description |
|----------------|---------------------|
| Any Channel | \pm 4.0 divisions |

Trigger Modes

| Mode | Description |
|----------------|--|
| Edge | Positive, negative, or dual slope on any input channel. Coupling includes DC, HF Reject, and Noise Reject |
| Pulse Width | Trigger on Channel 1, width of positive or negative pulses (glitches) that are >, <, =, or \neq a specified period of time (resolution of 0.01 div with minimum time of 50 ns) |
| Event | Trigger on N-th occurrence of trigger (N selectable from 2 to 99) |
| Video | Trigger on Channel 1, line number, all lines, odd, even, or all fields on NTSC, PAL, PAL Plus, and SECAM signals |
| Non-interlaced | Trigger on Channel 1, high-res non-interlaced video with line frequencies from 14 kHz to 65 kHz |

Acquisition Modes

| Mode | Description |
|------------------|--|
| Sample (Default) | Acquire sampled values |
| Glitch Detect | Captures high frequency or glitches as narrow as 8 ns from 5 μ s to 120 s / div |
| Averaging | Selectable from 2, 4, 8, or 64 waveforms |
| Roll | Scrolls waveforms right to left across the screen at sweep speeds slower than or equal to 4 ms/div |
| Data Recorder | Automatic data logging of 100 triggered records (screens) with date and time stamp. Store internally or to a USB device |
| Waveform Compare | Visually compare against user-definable reference waveforms or perform automatic Pass or Fail testing of 1 to 4 channels with data logging of test results |

Automatic Setup

| Mode | Description |
|-----------|--|
| Autoset | Single-button, automatic setup of all channels for vertical, horizontal, and trigger systems |
| Autorange | Continuous auto-setup of vertical, horizontal, and trigger systems that track signal changes |

Waveform Measurements

| Characteristic | Description |
|------------------------|---|
| Cursors | Time, Freq (1/T), Volts, Watts, Rise/Fall Time from any input channel or math waveform |
| Automatic Measurements | 21. Up to 4 can be displayed on-screen at any one time. Measurements include: V DC, V AC _{RMS} , V AC+DC, V _{Peak} Max, V _{Peak} Min, Peak to Peak, A DC, A AC, A AC+DC, Frequency, Rise Time (using cursors), Fall Time (using cursors), Phase (between any 2 inputs), Positive Pulse Width, Negative Pulse Width, Positive Duty Cycle, Negative Duty Cycle, dBV, dBm into 50 Ω and 600 Ω |
| TrendPlot™ | Records and graphically displays any 4 automatic scope measurements. Store internally or to USB flash drive for recall and analysis |

Waveform Math

| Characteristic | Description |
|----------------|---|
| Arithmetic | Add, subtract, and multiply waveforms |
| FFT | Spectral magnitude. Set FFT Vertical Scale to Linear or Logarithmic, and FFT Window to Automatic, Hamming, Hanning, or None |

Display Characteristics

| Characteristic | Description |
|--------------------|--|
| Display Type | 6 in. (153 mm) Liquid-crystal Color Display |
| Display Resolution | 320 horizontal \times 240 vertical pixels |
| Waveform Style | Vectors (dot-join), Dots, Envelope, Variable Persistence, Infinite Persistence |
| Display Format | YT and XY |

Storage Memory

| Characteristic | Description |
|-----------------|---|
| Reference | 4 user-definable reference traces |
| Waveform | Stores 30 internal scope records (4 traces each) with screen image and corresponding setup |
| Recording | Store 10 internal recordings that can be a 100-screen replay sequence, a Roll-mode recording, or a TrendPlot™ measurement recording |
| Screen Image | Store up to 9 internally or 256 BMP images to an external USB storage drive |
| Real-time Clock | Time and date stamp of all stored data |

Input/Output Ports

| Port | Description |
|--------------------------|--|
| USB Host Port | Supports USB mass storage devices |
| USB Device Port | Mini-USB-B connector allows for communication/control of oscilloscope |
| Probe Compensator Output | Side-panel Output – Amplitude: 1.225 V _{p-p} Frequency: 500 Hz |
| Kensington-style Lock | Side-panel security slot connects to standard Kensington-style lock |

Software

| Product | Description |
|---------------------|---|
| OpenChoice® Desktop | Enables fast and easy communication between a Windows PC and the THS3000 Series. Transfer and save settings, waveforms, and screen images |

Power Source

| Characteristic | Description |
|------------------------|--|
| Battery | 7 hour, 10.8 V rechargeable Li-Ion battery |
| Battery Charging Time | 5 hours |
| Line Power | AC power adapter/charger |
| Power Source Voltage | 100 V to 240 V AC \pm 10% |
| Power Source Frequency | 50 Hz to 60 Hz |

Physical Characteristics

| Dimension | mm | in. |
|-----------------------|-----|------|
| Height | 265 | 10.5 |
| Width | 190 | 7.5 |
| Depth | 70 | 2.8 |
| Weight | kg | lb. |
| Net (with battery) | 2.2 | 4.8 |
| Shipping (Base model) | 4.7 | 10.4 |
| Shipping (TK model) | 7.8 | 17.1 |

Environmental

| Characteristic | Description |
|-------------------------------|--|
| Enclosure | IP 41 according to IEC60529 |
| Temperature | |
| Operating | 0 °C to +40 °C (with battery) 0 °C to +50 °C (without battery) |
| Nonoperating | -20 °C to +60 °C |
| Humidity | |
| Operating | 10 °C to 30 °C, up to 95% relative humidity, noncondensing 30 °C to 40 °C, up to 75% relative humidity, noncondensing 40 °C to 50 °C, up to 45% relative humidity, noncondensing |
| Nonoperating | -20 °C to 60 °C, relative humidity, noncondensing |
| Altitude | |
| Operating | Up to 3,000 m (9,843 ft.) |
| Nonoperating | Up to 12,000 m (39,370 ft.) |
| Vibration/Shock | |
| Operating | Vibration (Sinusoidal): 3 g max, according to MIL-PRF-28800F, Class 2 Shock: 30 g max, according to MIL-PRF-28800F, Class 2 |
| Nonoperating | Vibration (Random): 0.03 g ² /Hz, according to MIL-PRF-2800F, Class 2 |
| Regulatory | |
| Electromagnetic Compatibility | EN 61326-1:2006, EN 61326-2-1:2006 for emission and immunity |
| Safety | UL61010-1:2004; CAN/CSA C22.2 No. 61010.1-04; EN61010-1:2001, Pollution Degree 2; ANSI/ISA-82.02.01 |

Ordering Information**THS3000 Models**

| Model | Description |
|------------|--|
| THS3014 | 100 MHz, 2.5 GS/s, 4-channel handheld oscilloscope |
| THS3014-TK | 100 MHz, 2.5 GS/s, 4-channel handheld oscilloscope with travel kit |
| THS3024 | 200 MHz, 5 GS/s, 4-channel handheld oscilloscope |
| THS3024-TK | 200 MHz, 5 GS/s, 4-channel handheld oscilloscope with travel kit |

All Models Include: THP0301-Y/B/M/G 300 MHz 10X Passive Probes, Lithium-ion Battery with 7-hour battery life, Carrying Handle, Hanging Strap, USB-A to Mini USB-B Cable for PC communication, Installation/Safety Manual, Documentation CD^{*2}, AC Power Adapter with Power Cord, ACHHS Soft-sided Carry Case (standard with base model), OpenChoice[®] Desktop PC Communication Software, Calibration Certificate Documenting Traceability to National Metrology Institute(s) and ISO9001 Quality System Registration, Three-year Warranty.

TK Models Also Include: Hard-sided travel case, soft-sided probe case, 2 probe replacement accessory kits.

Please specify power plug when ordering.

^{*2} Documentation CD available in English, French, German, Spanish, Italian, Portuguese, Korean, Japanese, Simplified Chinese, Traditional Chinese, and Russian (063-4379-xx).

Recommended Accessories

| Accessory | Description |
|-------------|---|
| THSBAT | Additional spare battery |
| THSCHG | Battery charger (does not include AC power adapter) |
| ACHHS | Instrument soft case |
| HCHHS | Instrument hard case (standard with TK models) |
| 376-0255-xx | Versatile hanging hook |
| 020-3085-xx | Probe replacement accessory kit |
| 119-7900-00 | AC power adapter |

Recommended Probes

| Probe | Description |
|------------------|--|
| THP0301-Y | (Yellow) 300 V, DC to 300 MHz, 10X high-voltage probe ^{*3} |
| THP0301-B | (Blue) 300 V, DC to 300 MHz, 10X high-voltage probe ^{*3} |
| THP0301-M | (Magenta) 300 V, DC to 300 MHz, 10X high-voltage probe ^{*3} |
| THP0301-G | (Green) 300 V, DC to 300 MHz, 10X high-voltage probe ^{*3} |
| A621 | 2000 A, 5 kHz to 50 kHz AC current probe/BNC |
| A622 | 100 A, 100 kHz AC/DC current probe/BNC |
| P5122 | 200 MHz passive 100X high-voltage probe |
| P5150 | 500 MHz passive 50X high-voltage probe ^{*4} |
| CT2 | 2.5 A, 200 MHz AC current probe |
| TCP303/TCPA300 | 150 A, 15 MHz AC/DC current probe/amplifier |
| TCP305/TCPA300 | 50 A, 50 MHz AC/DC current probe/amplifier |
| TCP312/TCPA300 | 30 A, 100 MHz, AC/DC current probe/amplifier |
| TCP404XL/TCPA400 | 500 A, 2 MHz AC/DC current probe/amplifier |

^{*3} One probe comes standard with the instrument.

^{*4} The P5150 is fully compatible with THS oscilloscopes, but 50X vertical scaling is not offered.

ASEAN / Australasia (65) 6356 3900

Austria 00800 2255 4835*

Balkans, Israel, South Africa and other ISE Countries +41 52 675 3777

Belgium 00800 2255 4835*

Brazil +55 (11) 3759 7627

Canada 1 800 833 9200

Central East Europe and the Baltics +41 52 675 3777

Central Europe & Greece +41 52 675 3777

Denmark +45 80 88 1401

Finland +41 52 675 3777

France 00800 2255 4835*

Germany 00800 2255 4835*

Hong Kong 400 820 5835

India 000 800 650 1835

Italy 00800 2255 4835*

Japan 81 (3) 6714 3010

Luxembourg +41 52 675 3777

Mexico, Central/South America & Caribbean 52 (55) 56 04 50 90

Middle East, Asia, and North Africa +41 52 675 3777

The Netherlands 00800 2255 4835*

Norway 800 16098

People's Republic of China 400 820 5835

Poland +41 52 675 3777

Portugal 80 08 12370

Republic of Korea 001 800 8255 2835

Russia & CIS +7 (495) 7484900

South Africa +41 52 675 3777

Spain 00800 2255 4835*

Sweden 00800 2255 4835*

Switzerland 00800 2255 4835*

Taiwan 886 (2) 2722 9622

United Kingdom & Ireland 00800 2255 4835*

USA 1 800 833 9200

* European toll-free number. If not accessible, call: +41 52 675 3777

Updated 10 February 2011

International Power Plugs

| Option | Description |
|----------|----------------------|
| Opt. A0 | North America power |
| Opt. A1 | Universal Euro power |
| Opt. A2 | United Kingdom power |
| Opt. A3 | Australia power |
| Opt. A5 | Switzerland power |
| Opt. A6 | Japan power |
| Opt. A10 | China power |
| Opt. A11 | India power |

Warranty

Three-year warranty covering all parts and labor, excluding probes.

For Further Information. Tektronix maintains a comprehensive, constantly expanding collection of application notes, technical briefs and other resources to help engineers working on the cutting edge of technology. Please visit www.tektronix.com



Copyright © Tektronix, Inc. All rights reserved. Tektronix products are covered by U.S. and foreign patents, issued and pending. Information in this publication supersedes that in all previously published material. Specification and price change privileges reserved. TEKTRONIX and TEK are registered trademarks of Tektronix, Inc. All other trade names referenced are the service marks, trademarks, or registered trademarks of their respective companies.

28 Dec 2011

3GW-27121-1

